

GIMBLE LOCK PLATE DETAIL
1:2

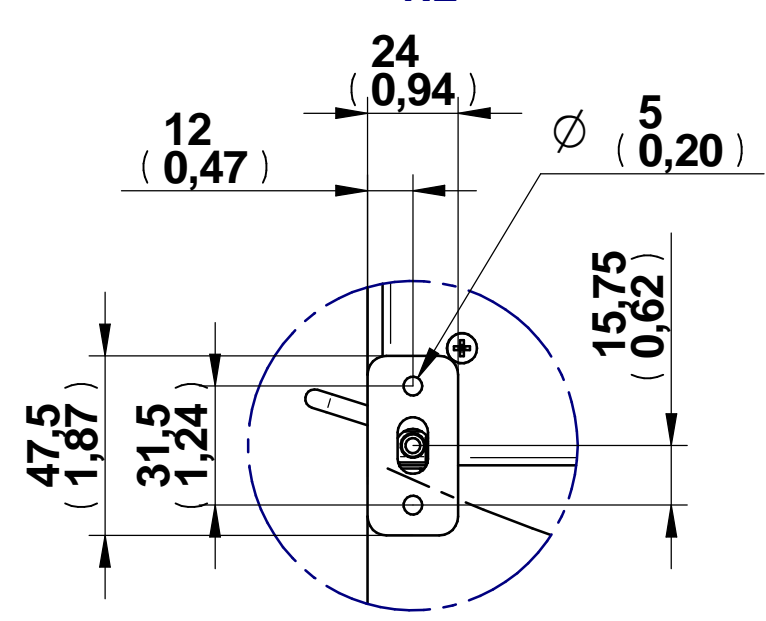

GIMBLE PLATE DETAIL
1:2

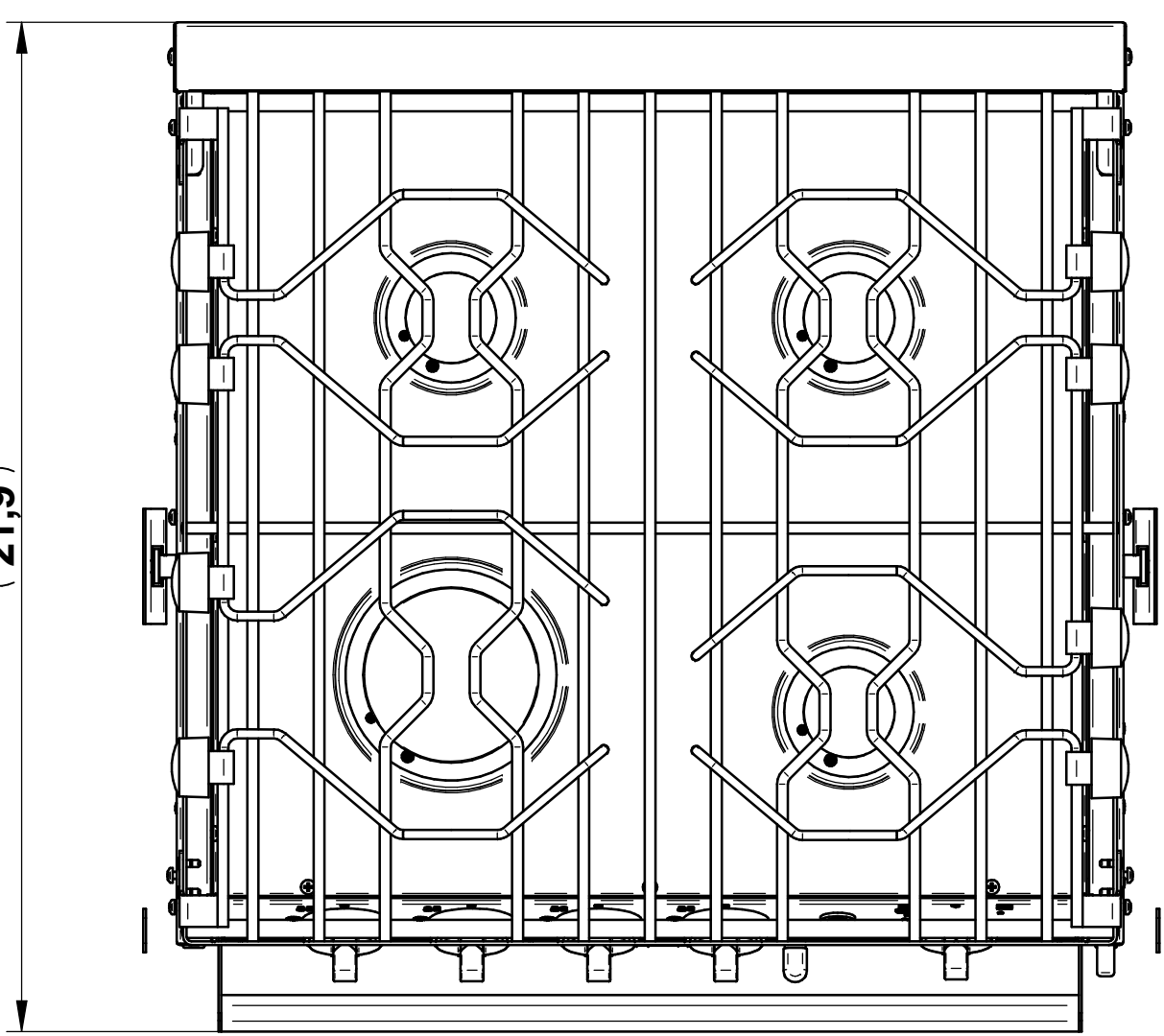
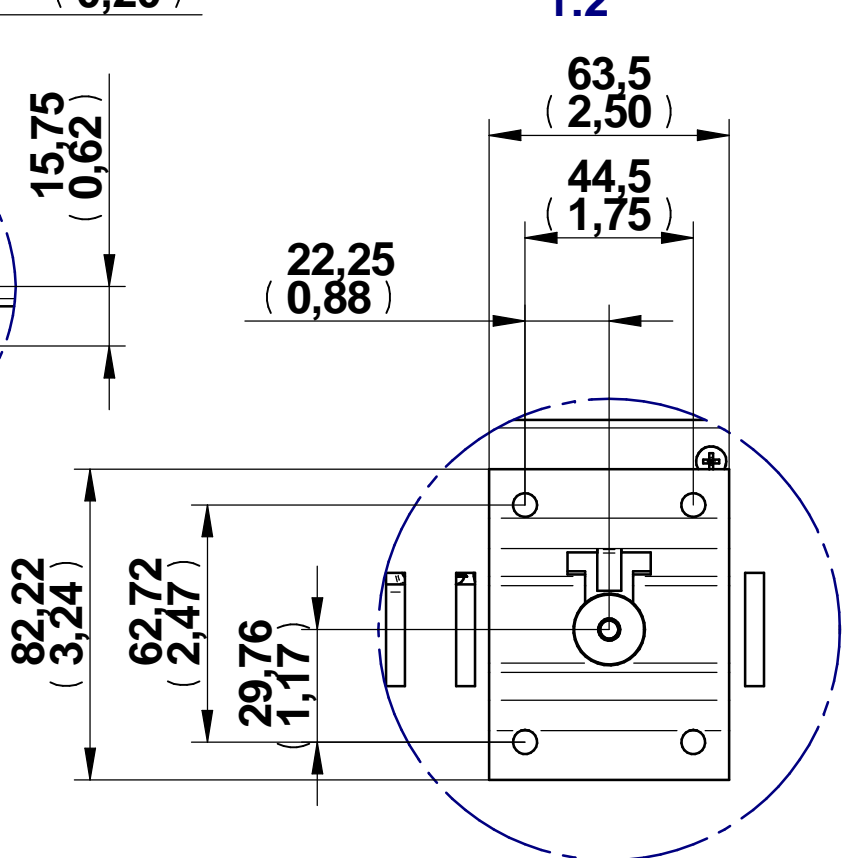

		mm	Inches
A		559	22
B	Gimble ±15°	540	21 1/4
	Bascule ±15°	578	22 3/4
	Gimble ±30°	578	22 3/4
	Bascule ±30°	578	22 3/4
C		603	23 3/4
D		56	2,20
E		65,5	2,60
F		540	21 1/4
G		181,5	7,15
H		213	8,40

Les dimensions sont en : mm
Dimensions are in : (inches)

Surface:	Trait. de Surface:	Masse: 0,000 kg
Ce document est la propriété exclusive de la société ENO. Toute communication, divulgation ou reproduction, même partielle doit faire l'objet d'une autorisation écrite de son propriétaire.		
Dessiné par: FG	le 16/05/2011	ECHELLE :
Vérifié par:	le	Format: A3
R-FOUR 4 FEUX NA STD 4 BURNER NA STD STOVE		 95, rue de la terraudière B.P. 8532 79025 NIORT Cedex 09
F63451		Pages 1 / 1
Dernière Modif. le 07/06/2011		